

INTRODUCTION

The details within this section are valid for a range of timber frame wall thicknesses. Details are given for the junctions with a range of roof, ground floor and internal floor types, as well as at external wall opes.

A variety of structural forms can be adopted, with variables such as stud centres, double or single head plates. The form of structure influences thermal performance, and must be taken into account when using these details.

Insulation thicknesses for the main elements have not been provided as these depend on the thermal properties of the materials chosen together with the proposed U-value. Further variables are insulation and sheathing types, plasterboard type and thickness, internal linings and external cladding. Details are shown with a masonry outer leaf for simplification. Other cladding may be used without loss of thermal performance or increased technical risk subject to suitable detail. All materials and workmanship are to be installed to Technical Guidance Document D "Materials and workmanship".

These diagrams illustrate good practice for design and construction of interfaces only in respect to ensuring thermal performance and air barrier continuity. Other issues are not considered fully. The guidance must be implemented with due regard to all other Building Regulations requirements.

Where these details are used for the Target U Values and constructions described in Table D4 of TGD L 2011 the psi values published in Table D4 may be used to calculate the actual Thermal Bridging heat loss for a dwelling for the key thermal bridging junctions in that dwelling.

Table D4	Section 4 - Timber Frame Construction	Target U-Values	
		0.21 W/m ² K U-value. Insulation between studs ^{1,3} (roof U = 0.16) (floor U = 0.21)	0.15 W/m ² K U-value. Insulation between studs and internal insulation ^{2,3} (roof U = 0.14) (floor U = 0.15)
Junction detail identifier 2011 Edition	Junction detail	ψ-value (W/mK)	ψ-value (W/mK)
Section 4 Details			
4.01	Ground Floor - Insulation above slab.	0.051	0.021
4.02	Ground Floor - Insulation below slab.	0.205	0.125
4.03	Timber Suspended Ground Floor	0.063	0.046
4.04.1	Corner	0.062	0.030
4.04.2	Inverted Corner	-0.004	-0.015
4.05	Timber Intermediate Floor within a dwelling	0.130	0.080
4.05a	Timber Separating floor between dwellings ⁵	0.193	0.132
4.06	Separating Wall (plan) ⁶	0.087	0.079
4.07	Separating Wall (section) ⁶	0.236	0.236
4.08	Partition Wall	0.000	0.000
4.09/4.10	Eaves - Unventilated/Ventilated roof space	0.082	0.044
4.11.1/4.12.1	Eaves - Insulation between and under rafters - Unventilated/Ventilated rafter void - Dormer	0.054	0.039
4.12.2	Eaves - Insulation between and under rafters - Unventilated/Ventilated rafter void - Pitched ceiling Dormer	0.014	0.013
4.13.1	Eaves - Ventilated - Insulation between and under rafters - Pitched ceiling	0.075	0.040
4.13.2	Pitched ceiling/insulation on flat	0.020	0.017
4.14	Eaves - Unventilated - Insulation between and over rafters	0.064	0.031
4.15	Ventilated roof - Attic floor level	0.081	0.051
4.16/4.17	Gable - Insulation between and under rafters - Unventilated/Ventilated rafter void	0.060	0.024
4.18	Gable - Insulation between and over rafters - Unventilated rafter void	0.062	0.037
4.19	Flat Roof - Parapet	0.041	0.046
4.20	Ope - Lintel	0.144	0.084
4.21	Ope - Jamb	0.064	0.043
4.22	Ope - Sill	0.048	0.034
4.23.1	Timber Frame Separating Wall through ground floor	0.118	0.149
4.23.2	Timber Frame Partition Wall through ground floor	0.074	0.096
Section G General Details			
G.01.1	Masonry Separating Wall Head - Section ⁶	0.511	0.484
G.01.2	Masonry Separating Wall Head - Section ⁶	0.488	0.458
G.05.1	Solid Masonry Separating Wall through ground floor	0.201	0.240
Other Details			
6.B.1	Balcony within dwelling ⁴	0.000	0.000
6.B.2	Balcony between dwelling ^{4,5}	0.020	0.020

- ψ values for a Target U-value for the wall of 0.21 W/m²K can be used for a range of U-values down to 0.18 W/m²K for the construction type specified. The U-values of the flanking elements to the wall can vary from the flanking element target U-value as follows: Pitched roof insulation on slope, insulation on ceiling = 0.13 to 0.16 W/m²K; Flat Roof = 0.16 to 0.2 W/m²K; Ground Floor = 0.16 to 0.21 W/m²K.
- ψ values for a Target U-value for the wall of 0.15 W/m²K can be used for a range of U-values from of 0.12 W/m²K to 0.17 W/m²K for the construction type specified. The U-values of the flanking elements to the wall can vary from the flanking element target U-value as follows: Pitched roof insulation on slope, insulation on ceiling 0.11 to 0.16 W/m²K; Flat Roof = 0.11 to 0.17 W/m²K; Ground Floor = 0.12 to 0.18.
- Where two building elements have one U-value above its target while the other is below its target U-value, the aggregate percentage change from the respective target U-values in the table should not exceed +20% for the Psi (ψ) value to be valid, i.e. if for the 0.15 U-value wall, if the U-value was increased by 10 % above the wall target U-value (from 0.15 to 0.165), then the roof U-value could be at most 10% below the roof target U-value (from 0.14 to 0.126), because the aggregate change would then be 20%.
- This is an externally supported balcony (the balcony slab is not a continuation of the floorslab) where the wall insulation is continuous and not bridged by the balcony slab.
- Value of Ψ is applied to each dwelling.
- Psi value is for whole junction. Half the value should be applied to each dwelling on either side of the junction.

THERMAL PERFORMANCE

CHECKLIST
(TICK ALL)

AIR BARRIER - CONTINUITY

CHECKLIST
(TICK ALL)

Floor insulation must tightly abut sole plate inner face

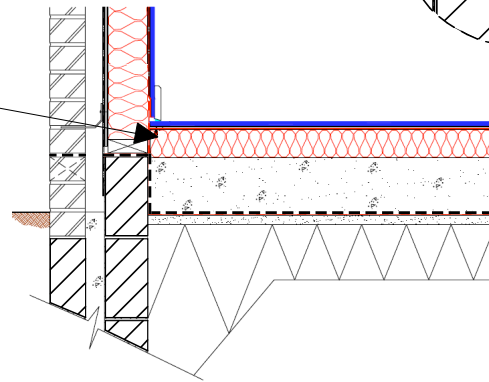

Seal between wall and floor air barrier OR seal gap between skirting board and floor using a flexible sealant

Seal all penetrations through air barrier using a flexible sealant or tape

Complying with checklist will help achieve design air permeability

GENERAL NOTES

If sole plates are packed to level, ensure any gaps are sealed

To improve air tightness, ensure sole plate DPC turns up behind and laps with vertical vapour control layer/vapour control plasterboard

Detail applicable:- Ground-bearing floor; raft foundation; in-situ suspended ground floor slab; pre-cast suspended ground floor. Insulation above slab, with timber floor finish

OPTION
(TICK ONE)

AIR BARRIER - OPTIONS

Internal lining, for example, plasterboard, or

Airtightness membrane and tapes

An effective vapour control layer may act as an airtightness membrane

THERMAL PERFORMANCE

CHECKLIST
(TICK ALL)

AIR BARRIER - CONTINUITY

CHECKLIST
(TICK ALL)

Floor slab perimeter insulation to have a min. R-value of 1.14 m² K/W

Floor insulation must tightly abut concrete block inner face

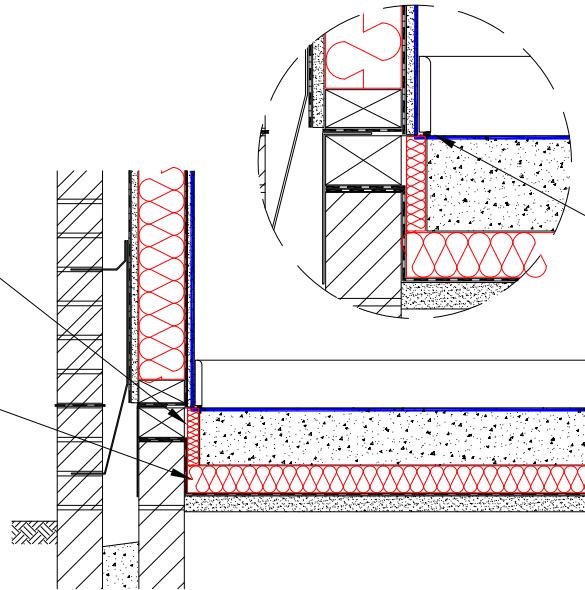

Seal between wall and floor air barrier OR seal gap between skirting board and floor using a flexible sealant

Seal all penetrations through air barrier using a flexible sealant or tape

Complying with checklist will help achieve design air permeability

GENERAL NOTES

If sole plates are packed to level, ensure any gaps are sealed

To improve air tightness, ensure sole plate DPC turns up behind and laps with vertical vapour control layer/vapour control plasterboard

Detail applicable:- Ground-bearing floor; Insulation below slab

OPTION
(TICK ONE)

AIR BARRIER - OPTIONS

Internal lining, for example, plasterboard, or

Airtightness membrane and tapes

THERMAL PERFORMANCE

CHECKLIST
(TICK ALL)

Ensure insulation is in contact with underside of timber flooring

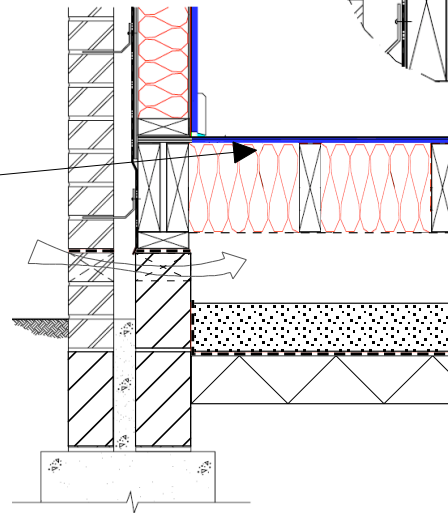

AIR BARRIER - CONTINUITY

CHECKLIST
(TICK ALL)

Seal between wall and floor air barrier, OR seal gap between skirting board and floor with a flexible sealant

Seal joints in timber floor with suitable glue. Fully support and fix any square edge joints in the decking to the joists

Seal all penetrations through air barrier using a flexible sealant or tape

Complying with checklist will help achieve design air permeability

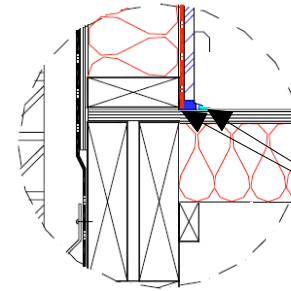

GENERAL NOTES

If installing compressible insulation, ensure full insulation depth between joists

OPTION
(TICK ONE)

AIR BARRIER - OPTIONS

Internal lining, for example, plasterboard, or

Airtightness membrane and tapes

An effective vapour control layer may act as an airtightness membrane

THERMAL PERFORMANCE

CHECKLIST
(TICK ALL)

Ensure insulation is tucked into corners



Corner
4.04.1

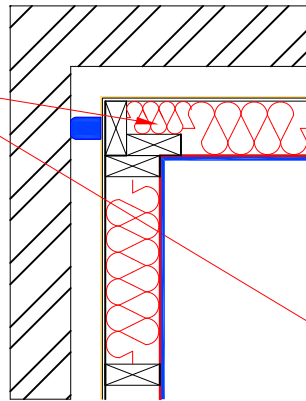

Inverted Corner
4.04.2

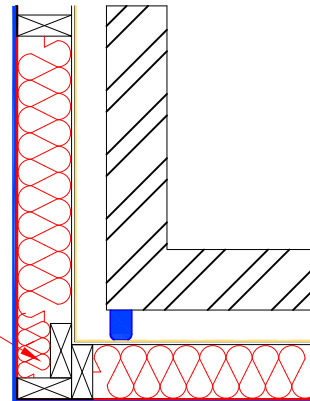

AIR BARRIER - CONTINUITY

CHECKLIST
(TICK ALL)



Seal all penetrations through air barrier using a flexible sealant or tape

Complying with checklist will help achieve design air permeability

GENERAL NOTES

Install cavity barriers as required

Provision of service cavity inside air barrier line will facilitate reduction in number of service penetrations through air barrier

OPTION
(TICK ONE)

AIR BARRIER - OPTIONS



Internal lining, for example, plasterboard, or



Airtightness membrane and tapes

THERMAL PERFORMANCE

CHECKLIST
(TICK ALL)

AIR BARRIER - CONTINUITY

CHECKLIST
(TICK ALL)

Install insulation with min. R-value of 3.50 m² K/W between joists

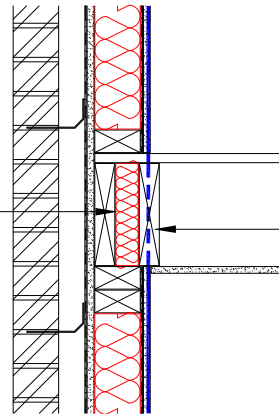

Seal gap between skirting board and floor with a flexible sealant

Dotted blue line is notional, to depict air barrier continuity through floor zone, e.g., solid noggings or header joist. (If outside structure, use breathable membrane)

Seal all penetrations through air barrier using a flexible sealant or tape

Complying with checklist will help achieve design air permeability

GENERAL NOTES

Install cavity barriers as required

Provision of service cavity inside air barrier line will facilitate reduction in number of service penetrations through air barrier

OPTION
(TICK ONE)

AIR BARRIER - OPTIONS

Internal lining, for example, plasterboard, or

Airtightness membrane and tapes

THERMAL PERFORMANCE

CHECKLIST
(TICK ALL)

AIR BARRIER - CONTINUITY

CHECKLIST
(TICK ALL)

Install insulation with min. R-value of 3.50 m² K/W between joists

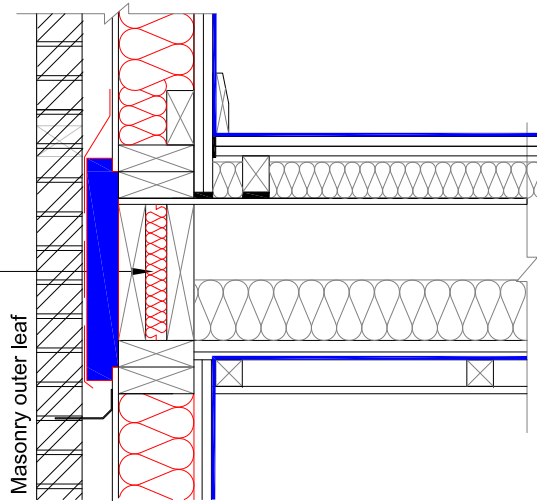

Seal gap between skirting board and floor with a flexible sealant

Seal all penetrations through air barrier using a flexible sealant or tape

Complying with checklist will help achieve design air permeability

GENERAL NOTES

Install cavity barriers as required

Provision of service cavity inside air barrier line will facilitate reduction in number of service penetrations through air barrier

See Part E for sound requirements.

See Part B for fire requirements.

OPTION
(TICK ONE)

AIR BARRIER - OPTIONS

Internal lining, for example, plasterboard, or

Airtightness membrane and tapes

THERMAL PERFORMANCE

CHECKLIST
(TICK ALL)

AIR BARRIER - CONTINUITY

CHECKLIST
(TICK ALL)

Ensure insulation is tucked into corner studs

Pack between external wall studs with suitable firestopping insulation. Min. R-value of 5.23 m² K/W

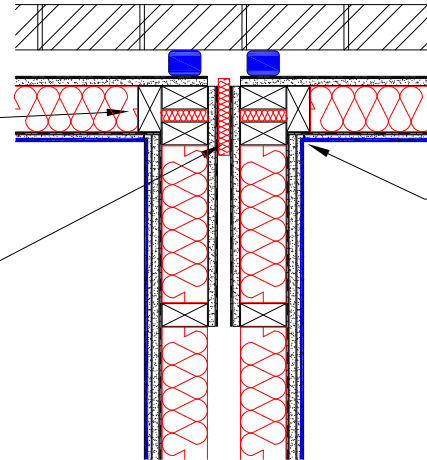

Ensure air barrier continuity between internal linings at corners

Seal all penetrations through air barrier using a flexible sealant or tape

Complying with checklist will help achieve design air permeability

GENERAL NOTES

Install cavity barriers as required. Use appropriate material where cavity barrier or full-fill insulation is employed

Provision of service cavity inside air barrier line will facilitate reduction in number of service penetrations through air barrier

See TGD-B for guidance on fire safety and TGD-E for guidance on sound insulation

Read this detail in conjunction with detail 4.07, Separating Wall (section)

OPTION
(TICK ONE)

AIR BARRIER - OPTIONS

Internal lining, for example, plasterboard, or

Airtightness membrane and tapes

THERMAL PERFORMANCE

CHECKLIST
(TICK ALL)

AIR BARRIER - CONTINUITY

CHECKLIST
(TICK ALL)

Ensure full depth of insulation between, over (or below) joists extends to wall face

Pack compressible insulation between last truss / joist and separating wall. Min. R-value of 1.10 m² K/W

Pack compressible firestopping insulation between wall head members. Min. R-value of 2.50 m² K/W

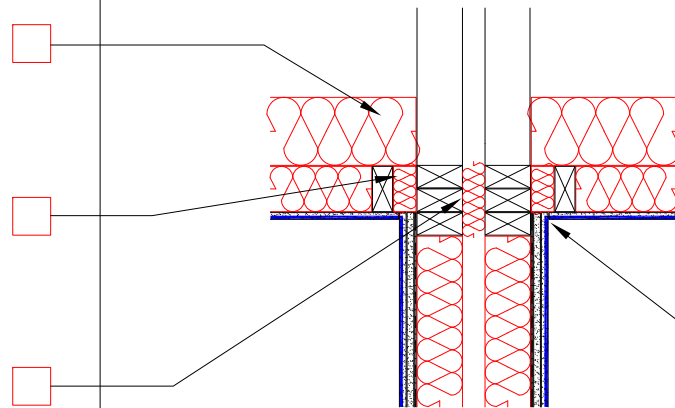

Seal all penetrations through air barrier using a flexible sealant or tape

Ensure air barrier continuity between ceiling and wall linings

Complying with checklist will help achieve design air permeability

GENERAL NOTES

Install cavity barriers as required

See TGD-B for guidance on fire safety and TGD-E for guidance on sound insulation

Read this detail in conjunction with detail 4.06, Separating Wall (plan)

OPTION
(TICK ONE)

AIR BARRIER - OPTIONS

Internal lining, for example, plasterboard, or

Airtightness membrane and tapes

THERMAL PERFORMANCE

CHECKLIST
(TICK ALL)

Ensure insulation is tucked into corner

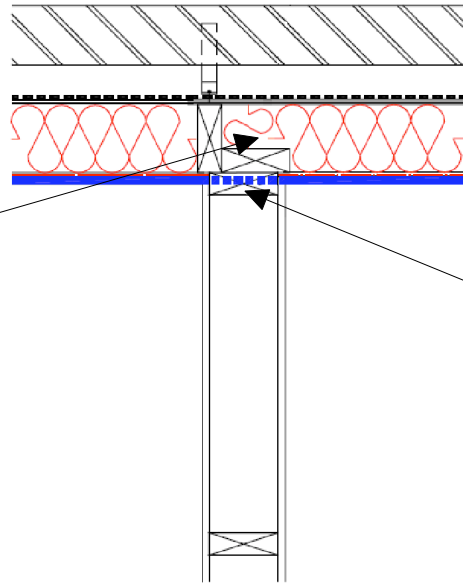

AIR BARRIER - CONTINUITY

CHECKLIST
(TICK ALL)



Seal all penetrations through air barrier using a flexible sealant or tape



Dotted blue line is notional, to depict air barrier continuity through partition zone, e.g., timber stud

Complying with checklist will help achieve design air permeability

GENERAL NOTES

Read this detail in conjunction with detail G-03, Partition Wall (head)

Provision of service cavity inside air barrier line will facilitate reduction in number of service penetrations through air barrier

OPTION
(TICK ONE)

AIR BARRIER - OPTIONS



Internal lining, for example, plasterboard, or



Airtightness membrane and tapes

An effective vapour control layer may act as an airtightness membrane

THERMAL PERFORMANCE

CHECKLIST
(TICK ALL)

AIR BARRIER - CONTINUITY

CHECKLIST
(TICK ALL)

Ensure continuity of insulation throughout junction

Ensure full depth of insulation between and over joists abuts eaves insulation

Ensure gap between wall plate and proprietary eaves guard is completely filled with insulation having a min. R-value across the insulation thickness of 2.00 m² K/W

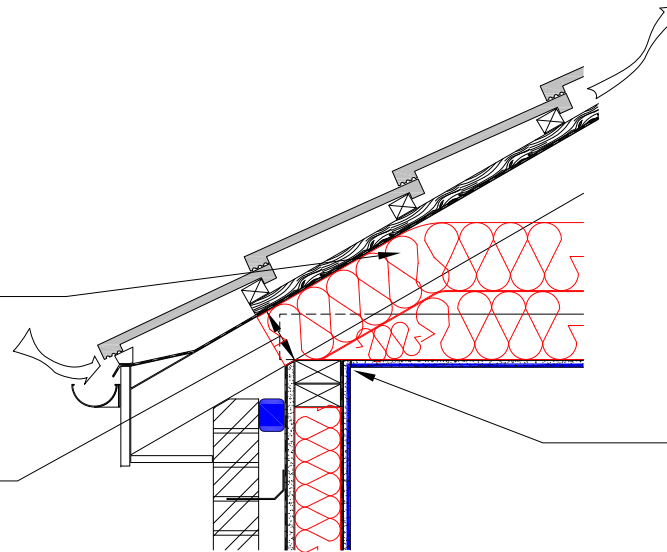

Seal all penetrations through air barrier using a flexible sealant or tape

Ensure air barrier continuity between ceiling and wall linings

Complying with checklist will help achieve design air permeability

GENERAL NOTES

- Use of over joist insulation is considered best practice, as it eliminates the cold bridge caused by the joist
- Use proprietary eaves ventilator to ensure ventilation in accordance with BS5250
- Use vapour permeable roof underlay in strict accordance with third party certification
- Eaves insulation must not hinder free water drainage below tiling battens
- Install cavity barriers as required
- Read this detail in conjunction with detail 4-15, Gable - Attic Floor Level

OPTION
(TICK ONE)

AIR BARRIER - OPTIONS

- Internal lining, for example, plasterboard, or
- Airtightness membrane and tapes

THERMAL PERFORMANCE

CHECKLIST
(TICK ALL)

AIR BARRIER - CONTINUITY

CHECKLIST
(TICK ALL)

Ensure continuity of insulation throughout junction

Ensure full depth of insulation between and over joists abuts eaves insulation

Ensure gap between wall plate and proprietary eaves vent is completely filled with insulation having a min. R-value across the insulation thickness of 2.00 m² K/W

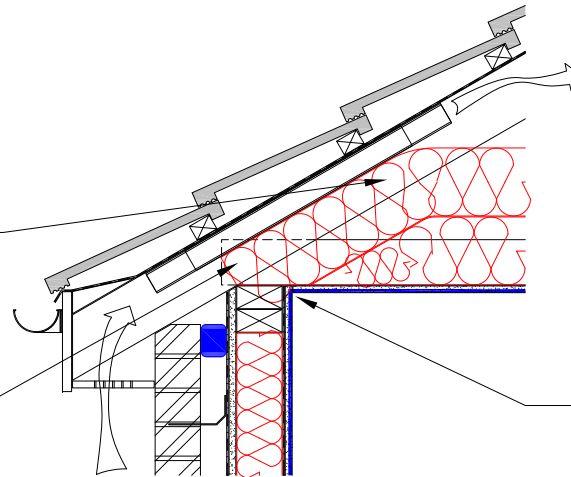

Seal all penetrations through air barrier using a flexible sealant or tape

Ensure air barrier continuity between ceiling and wall linings

Complying with checklist will help achieve design air permeability

GENERAL NOTES

Thermal performance of junction can be improved by incorporating an eaves wind barrier (plywood, OSB, softboard or other suitable material) around insulation to be sealed to connect with the ventilator strip thereby mitigating wind chill from the vent inlet in the eaves.

Use of over joist insulation is considered best practice, as it eliminates the cold bridge caused by the joist

Use a proprietary eaves ventilator to ensure ventilation in accordance with BS5250. Installation of the eaves ventilator must not prevent free water drainage below the tiling battens

Install cavity barriers as required

Read this detail in conjunction with detail 4-15, Gable - Attic Floor Level

OPTION
(TICK ONE)

AIR BARRIER - OPTIONS

Internal lining, for example, plasterboard, or

Airtightness membrane and tapes

THERMAL PERFORMANCE

CHECKLIST
(TICK ALL)

- Ensure continuity of insulation throughout junction
- Ensure insulation is installed tightly between rafters and is in contact with under-rafter insulation
- Ensure full depth of insulation between and over joists abuts eaves insulation
- Ensure gap between wall plate and proprietary eaves vent is completely filled with insulation having a min. R-value across the insulation thickness of 3.90 m² K/W

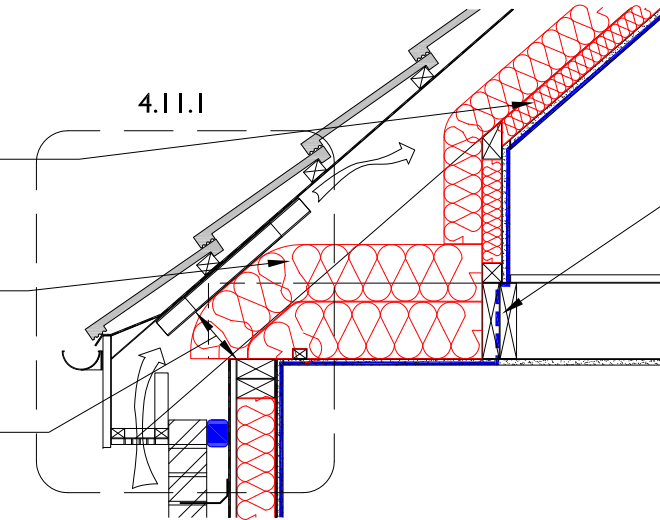

AIR BARRIER - CONTINUITY

CHECKLIST
(TICK ALL)

- Install full depth timber nogging between floor joists, and seal between nogging, ceiling and upper stud wall with a flexible sealant. (Dotted blue line is notional, to depict air barrier continuity through noggings.)
- Ensure air barrier continuity between ceiling and wall linings
- Seal all penetrations through air barrier using a flexible sealant or tape

Complying with checklist will help achieve design air permeability

GENERAL NOTES

Thermal performance of junction can be improved by incorporating an eaves wind barrier (plywood, OSB, softboard or other suitable material) around insulation to be sealed to connect with the ventilator strip thereby mitigating wind chill from the vent inlet in the eaves.
 If required by BS5250, use vapour control plasterboard or separate vapour control layer behind plasterboard.
 Use proprietary eaves ventilator to ensure ventilation in accordance with BS5250. Installation of eaves ventilator must not prevent free water drainage below tiling battens
 Use of over joist and under rafter insulation is considered best practice, as it eliminates the cold bridge caused by the joist/rafter
 Install cavity barriers as required
 Read this detail in conjunction with details 4-15, Gable - Attic Floor Level, and 4-16, Gable - Insulation between and under rafters - Ventilated Rafter Void

OPTION
(TICK ONE)

AIR BARRIER - OPTIONS

- Internal lining, for example, plasterboard, or
- Airtightness membrane and tapes

THERMAL PERFORMANCE

CHECKLIST (TICK ALL)

AIR BARRIER - CONTINUITY

CHECKLIST (TICK ALL)

- Ensure continuity of insulation throughout junction
- Ensure insulation is installed tightly between rafters and is in contact with under-rafter insulation
- Ensure full depth of insulation between and over joists abuts eaves insulation
- Ensure gap between wall plate and proprietary eaves guard is completely filled with insulation having a min. R-value across the insulation thickness of 3.90 m² K/W

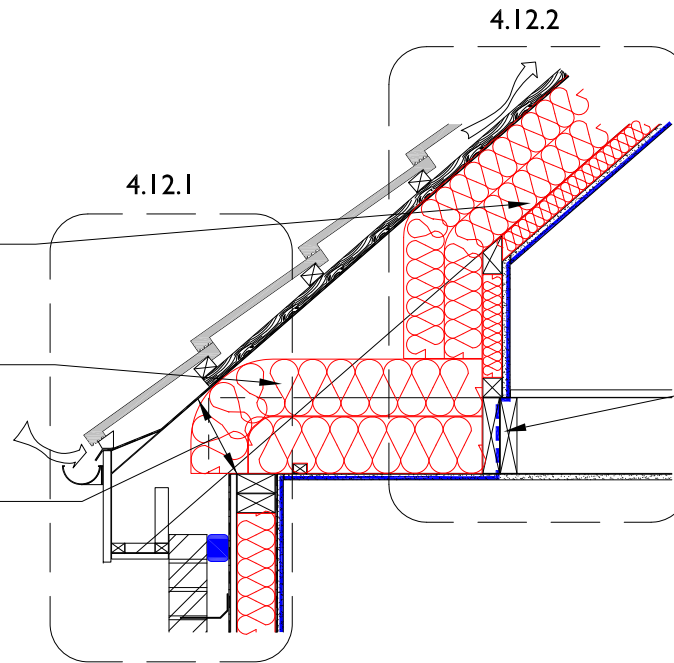

- Ensure air barrier continuity between ceiling and wall linings
- Install double, full depth timber noggings between floor joists. (Dotted blue line is notional, to depict air barrier continuity through noggings.)
- Seal all penetrations through air barrier using a flexible sealant or tape

Complying with checklist will help achieve design air permeability

GENERAL NOTES

- If required by BS5250, use vapour control plasterboard or separate vapour control layer behind plasterboard.
- Vapour permeable roof underlay to be used in strict accordance with approved third party certification
- Use of over joist and under rafter insulation is considered best practice, as it eliminates the cold bridge caused by the joist/rafter
- Eaves insulation must not hinder free water drainage below tiling battens
- Install cavity barriers as required
- Read this detail in conjunction with details 4-15, Gable - Attic floor level, and 4-17, Gable - Insulation between and under rafters - Unventilated Rafter Void

OPTION (TICK ONE)

AIR BARRIER - OPTIONS

- Internal lining, for example, plasterboard, or
- Airtightness membrane and tapes

THERMAL PERFORMANCE

CHECKLIST
(TICK ALL)

- Ensure continuity of insulation throughout junction
- Ensure insulation is installed tightly between rafters and is in contact with under-rafter insulation
- Ensure full depth of insulation between and under rafters abuts eaves insulation
- Ensure gap between wall plate and proprietary eaves vent is completely filled with insulation having a min. R-value across the insulation thickness of 3.00 m² K/W

4.13.1

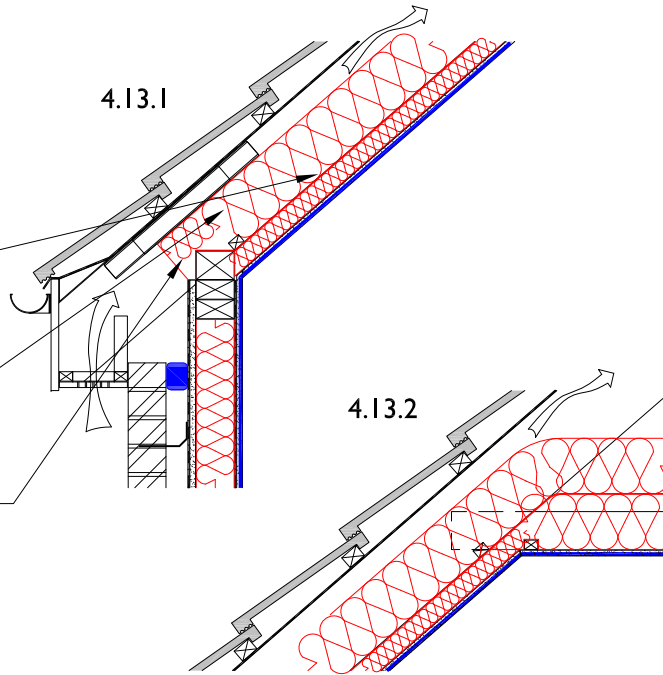

4.13.2

AIR BARRIER - CONTINUITY

CHECKLIST
(TICK ALL)

- Seal all penetrations through air barrier using a flexible sealant or tape
- Ensure air barrier continuity between ceiling and wall linings

Complying with checklist will help achieve design air permeability

GENERAL NOTES

Thermal performance of junction can be improved by incorporating an eaves wind barrier (plywood, OSB, softboard or other suitable material) around insulation to be sealed to connect with the ventilator strip thereby mitigating wind chill from the vent inlet in the eaves.

Use a proprietary eaves ventilator to ensure ventilation in accordance with BS5250. Installation of eaves ventilator must not prevent free water drainage below tiling battens

If required by BS5250, use vapour control plasterboard or separate vapour control layer behind plasterboard

Use of over joist and under rafter insulation is considered best practice, as it eliminates the cold bridge caused by the joist/rafter

Install cavity barriers as required

Read this detail in conjunction with details 4-15, Gable - Attic Floor Level, and 4-16, Gable - Insulation between and under rafters - Ventilated Rafter Void

OPTION
(TICK ONE)

AIR BARRIER - OPTIONS

- Internal lining, for example, plasterboard, or
- Airtightness membrane and tapes

Eaves - Insulation between and over rafters - Unventilated Rafter Void - Dormer

THERMAL PERFORMANCE

CHECKLIST
(TICK ALL)

Ensure continuity of insulation throughout junction

Ensure insulation is installed tightly between rafters and is in contact with over-rafter insulation

Ensure full depth of insulation between and over rafters abuts eaves insulation

Ensure gap between wall plate and over rafter insulation is completely filled with insulation having a min. R-value across the insulation thickness of 3.00 m² K/W

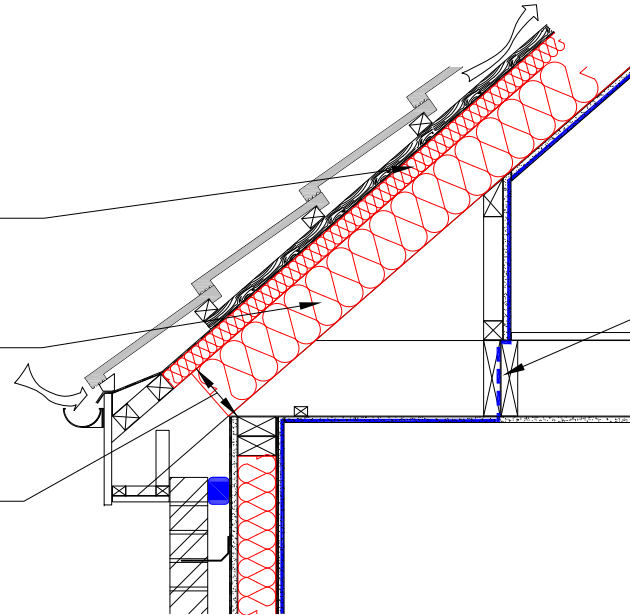

AIR BARRIER - CONTINUITY

CHECKLIST
(TICK ALL)

Ensure air barrier continuity between ceiling and wall plasterboard

Install full depth timber nogging between floor joists. (Dotted blue line is notional, to depict air barrier continuity through noggings.)

Seal all penetrations through air barrier using a flexible sealant or tape

Complying with checklist will help achieve design air permeability

GENERAL NOTES

Vapour permeable roof underlay to be used in strict accordance with approved third party certification

If required by BS5250, use vapour control plasterboard or separate vapour control layer behind plasterboard.

Use of over rafter insulation is considered best practice, as it eliminates the cold bridge caused by the joist/rafter

Install cavity barriers as required

Read this detail in conjunction with detail 4-18, Gable - Insulation between and over rafters

OPTION
(TICK ONE)

AIR BARRIER - OPTIONS

Internal lining, for example, plasterboard, or

Airtightness membrane and tapes

THERMAL PERFORMANCE

CHECKLIST
(TICK ALL)

AIR BARRIER - CONTINUITY

CHECKLIST
(TICK ALL)

Continue wall insulation to a minimum of 250mm over the top of attic insulation.

Continue attic insulation over head of main wall panel, to sheathing board

Ensure full depth of insulation between and over joists extends to inner edge of wall

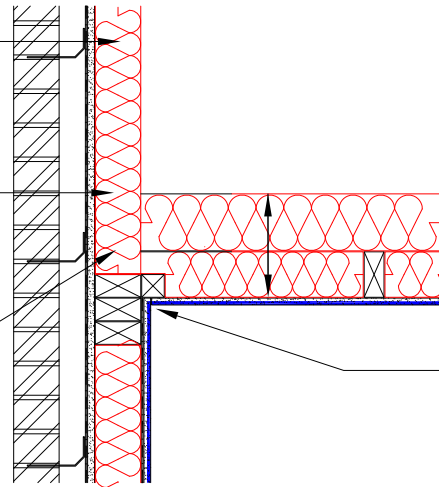

Seal all penetrations through air barrier using a flexible sealant or tape

Ensure air barrier continuity between ceiling and wall linings

Complying with checklist will help achieve design air permeability

GENERAL NOTES

Use of over joist insulation is considered best practice, as it eliminates the cold bridge caused by the joist

Install cavity barriers as required

Read this detail in conjunction with details 4-09, Ventilated Attic, or 4-10, Eaves - Unventilated Attic, as appropriate

OPTION
(TICK ONE)

AIR BARRIER - OPTIONS

Internal lining, for example, plasterboard, or

Airtightness membrane and tapes

THERMAL PERFORMANCE

CHECKLIST
(TICK ALL)

Ensure full depth of insulation between and under rafters extends to wall

Ensure insulation is installed tightly between rafters and is in contact with under-rafter insulation

Ensure wall insulation is taken up level with top of wall

Ensure insulation continuity throughout junction

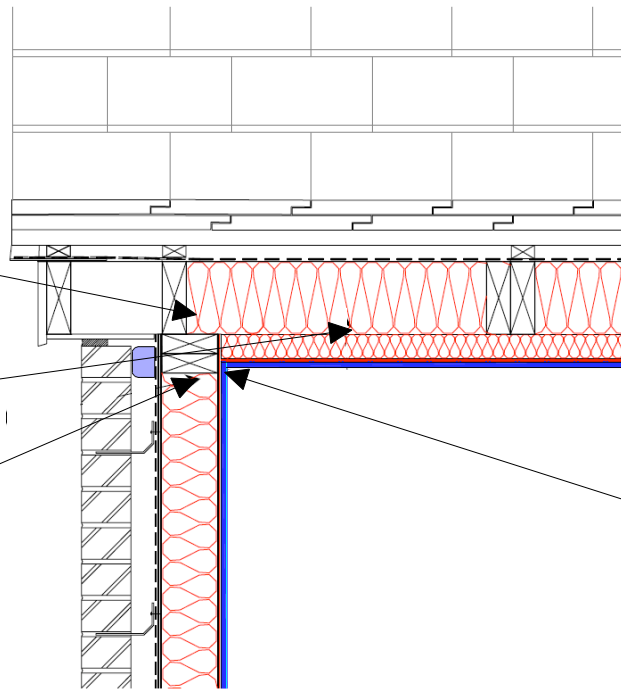

AIR BARRIER - CONTINUITY

CHECKLIST
(TICK ALL)

Seal all penetrations through air barrier using a flexible sealant or tape

Ensure air barrier continuity between ceiling and wall linings

Complying with checklist will help achieve design air permeability

GENERAL NOTES

Vapour permeable roof underlay to be used in strict accordance with approved third party certification

If required by BS5250, use vapour control plasterboard or separate vapour control layer behind plasterboard.

Install cavity barriers as required

Read this detail in conjunction with detail 4-12, Eaves - Insulation between and under rafters - Unventilated Rafter Void

OPTION
(TICK ONE)

AIR BARRIER - OPTIONS

Internal lining, for example, plasterboard, or

Airtightness membrane and tapes

An effective vapour control layer may act as an airtightness membrane

THERMAL PERFORMANCE

CHECKLIST
(TICK ALL)

Ensure full depth of insulation between and under rafters extends to wall

Ensure insulation is installed tightly between rafters and is in contact with under-rafter insulation

Ensure wall insulation is taken up level with top of wall

Ensure insulation continuity throughout junction

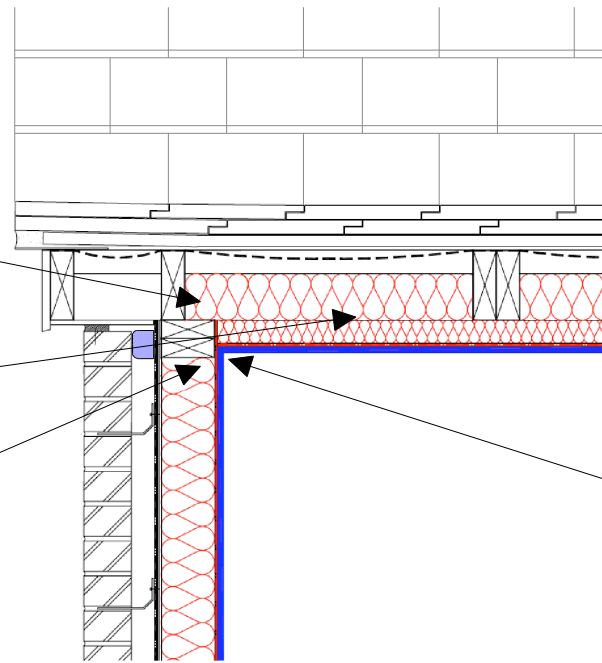

AIR BARRIER - CONTINUITY

CHECKLIST
(TICK ALL)

Seal all penetrations through air barrier using a flexible sealant or tape

Ensure air barrier continuity between ceiling and wall linings

Complying with checklist will help achieve design air permeability

GENERAL NOTES

Ventilate roof in accordance with BS 5250

If required by BS5250, use vapour control plasterboard or separate vapour control layer behind plasterboard.

Use of under rafter insulation is considered best practice, as it eliminates the cold bridge caused by the rafter

Install cavity barriers as required

Read this detail in conjunction with detail 4-11, Eaves - Insulation between and under rafters - Ventilated Rafter Void

OPTION
(TICK ONE)

AIR BARRIER - OPTIONS

Internal lining, for example, plasterboard, or

Airtightness membrane and tapes

An effective vapour control layer may act as an airtightness membrane

THERMAL PERFORMANCE

CHECKLIST (TICK ALL)

AIR BARRIER - CONTINUITY

CHECKLIST (TICK ALL)

Min. R-value of 1.09 m² K/W

Ensure full depth of insulation between and over rafters extends to wall

Ensure insulation continuity throughout junction

Ensure insulation is installed tightly between rafters and is in contact with over-rafter insulation

Ensure wall insulation is taken up level with top of wall

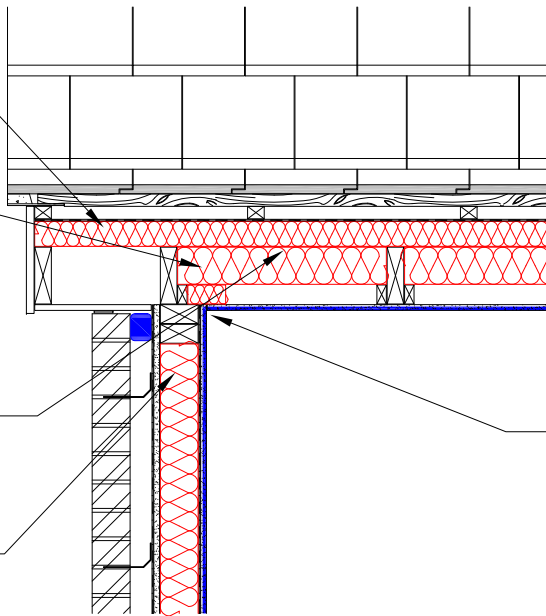

Seal all penetrations through air barrier using a flexible sealant or tape

Ensure air barrier continuity between ceiling and wall linings

Complying with checklist will help achieve design air permeability

GENERAL NOTES

Vapour permeable roof underlay to be used in strict accordance with approved third party certification

If required by BS5250, use vapour control plasterboard or separate vapour control layer behind linings

Use of over-rafter insulation is considered best practice, as it eliminates the cold bridge caused by the rafter

Install cavity barriers as required

Read this detail in conjunction with detail 4-14, Eaves - Insulation between and over rafters

OPTION (TICK ONE)

AIR BARRIER - OPTIONS

Internal lining, for example, plasterboard, or

Airtightness membrane and tapes

THERMAL PERFORMANCE

CHECKLIST
(TICK ALL)

Ensure wall insulation is installed level with, or above, top of roof insulation

Ensure roof insulation tightly abuts inner face of parapet wall

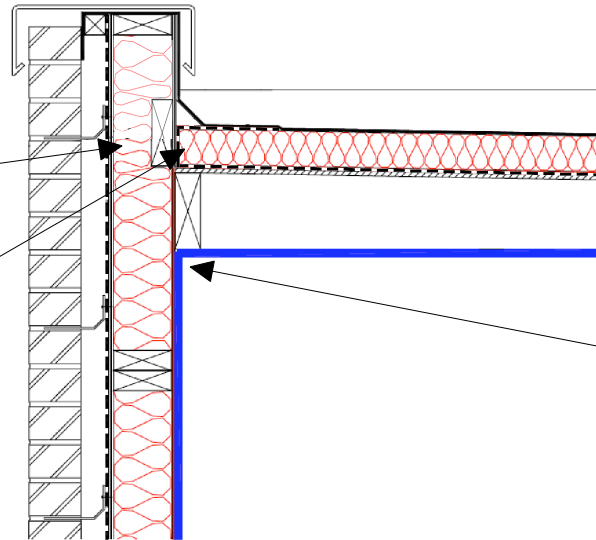

AIR BARRIER - CONTINUITY

CHECKLIST
(TICK ALL)

Seal all penetrations through air barrier using a flexible sealant or tape

Ensure air barrier continuity between ceiling and wall linings

Complying with checklist will help achieve design air permeability

GENERAL NOTES

BS5250 requires vapour control layer to be installed between deck and insulation

Turn up vapour control layer at edge of roof insulation, lap with roof waterproofing layer, and seal

Install cavity barriers as required

OPTION
(TICK ONE)

AIR BARRIER - OPTIONS

Internal lining, for example, plasterboard, or

Airtightness membrane and tapes

An effective vapour control layer may act as an airtightness membrane

THERMAL PERFORMANCE

CHECKLIST
(TICK ALL)

AIR BARRIER - CONTINUITY

CHECKLIST
(TICK ALL)

Install proprietary cavity closer with thermal resistance path through closer of 1.00 m² K/W or better (Manufacturers' certified data)

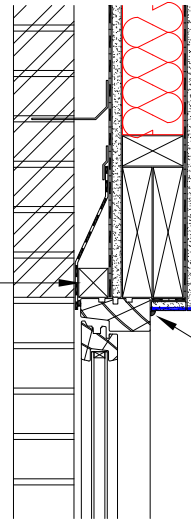

Seal all penetrations through air barrier using a flexible sealant or tape

Apply external flexible seal around frame

Apply flexible sealant to interface between plasterboard internal finish, and frame members

Complying with checklist will help achieve design air permeability

GENERAL NOTES

Ensure vapour control layer or vapour control plasterboard is returned into reveal

OPTION
(TICK ONE)

AIR BARRIER - OPTIONS

Internal lining, for example, plasterboard, or

Airtightness membrane and tapes

THERMAL PERFORMANCE

CHECKLIST
(TICK ALL)

AIR BARRIER - CONTINUITY

CHECKLIST
(TICK ALL)

Install proprietary cavity closer with thermal resistance path through closer of 1.00 m² K/W or better (Manufacturers' certified data)

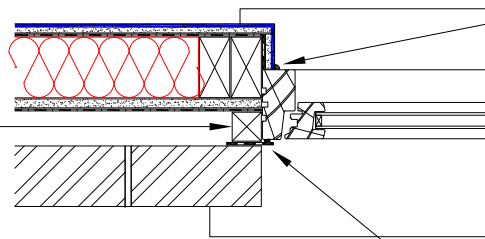

Apply flexible sealant to junction between lining, and frame members

Seal all penetrations through air barrier using a flexible sealant or tape

Apply external flexible seal around frame

Complying with checklist will help achieve design air permeability

GENERAL NOTES

Ensure vapour control layer or vapour control plasterboard is returned into reveal

OPTION
(TICK ONE)

AIR BARRIER - OPTIONS

Internal lining, for example, plasterboard, or

Airtightness membrane and tapes

THERMAL PERFORMANCE

CHECKLIST
(TICK ALL)

Ensure insulation brought tight to underside of cill plate

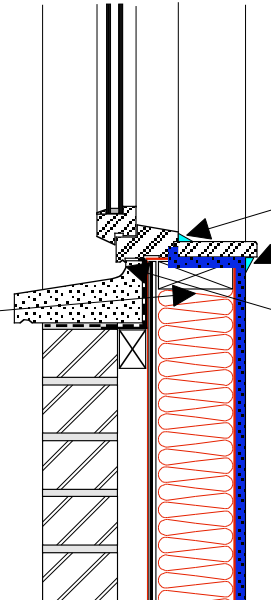

AIR BARRIER - CONTINUITY

CHECKLIST
(TICK ALL)

Apply flexible sealant to junction between lining and windowboard, and between windowboard and frame

Ensure air barrier continuity between wall linings and frame

Apply external flexible seal around frame

Seal all penetrations through air barrier using a flexible sealant or tape

Complying with checklist will help achieve design air permeability

GENERAL NOTES

Ensure vapour control layer or vapour control plasterboard is returned into reveal

OPTION
(TICK ONE)

AIR BARRIER - OPTIONS

Internal lining, for example, plasterboard, or

Airtightness membrane and tapes

An effective vapour control layer may act as an airtightness membrane

THERMAL PERFORMANCE

CHECKLIST
(TICK ALL)

Edge insulation to have a minimum R-value of 1.14 m²K/W

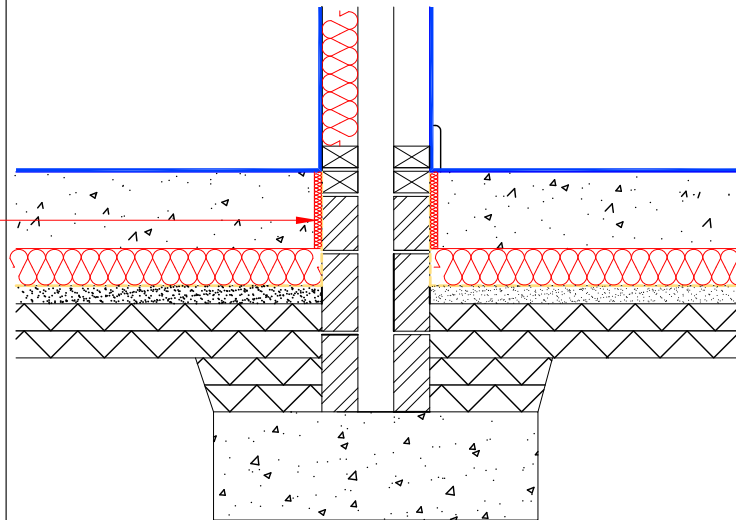

AIR BARRIER - CONTINUITY

CHECKLIST
(TICK ALL)

Complying with checklist will help achieve design air permeability

GENERAL NOTES

See TGD-B for guidance on fire safety and TGD-E for guidance on sound insulation

OPTION
(TICK ONE)

AIR BARRIER - OPTIONS



Internal lining, for example, plaster, or



Airtightness tapes

THERMAL PERFORMANCE

CHECKLIST
(TICK ALL)

Edge insulation to have a minimum
R-value of 1.14 m²K/W

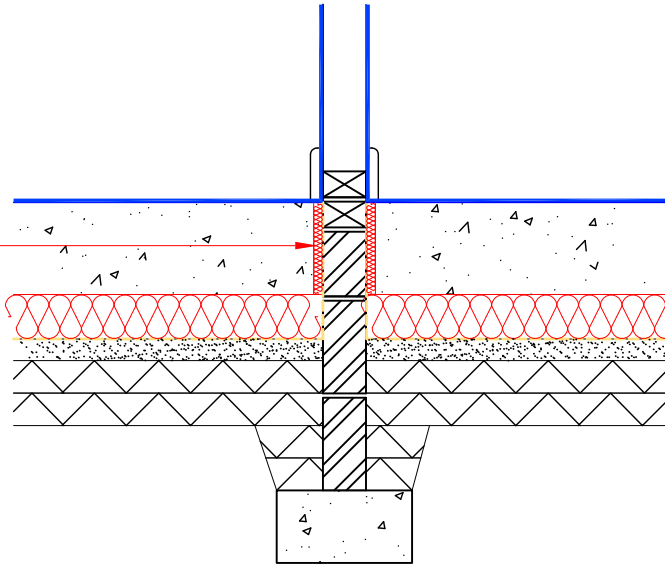

AIR BARRIER - CONTINUITY

CHECKLIST
(TICK ALL)

Complying with checklist will help achieve design air permeability

GENERAL NOTES

OPTION
(TICK ONE)

AIR BARRIER - OPTIONS



Internal lining, for example, plaster, or



Airtightness tapes